

4

3

2

1

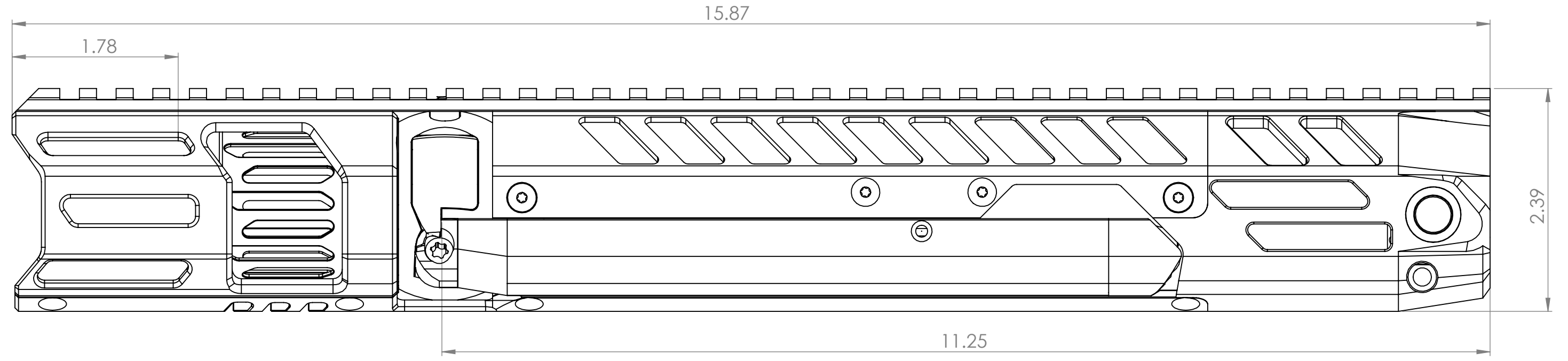

Max. Gas block height : 1.5
 Max. Gas block width : 1.05

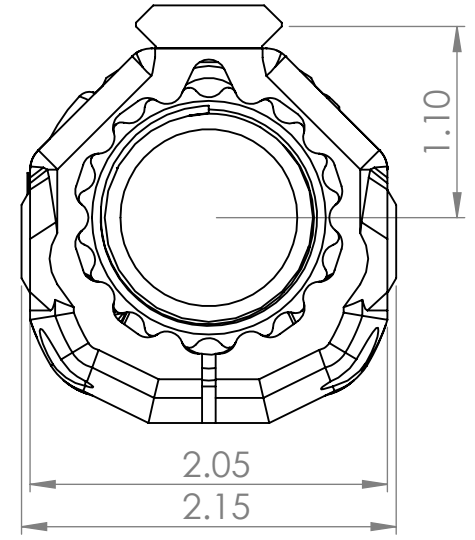
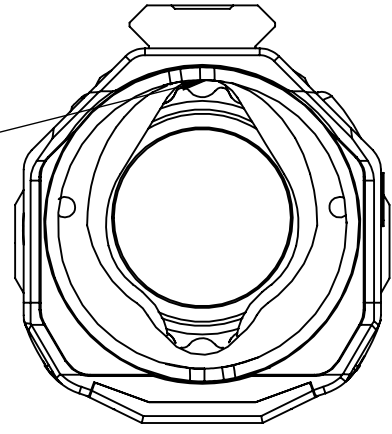

PROPRIETARY AND CONFIDENTIAL
 THE INFORMATION CONTAINED IN THIS
 DRAWING IS THE SOLE PROPERTY OF
 BLK LBL CORP. ANY
 REPRODUCTION IN PART OR AS A WHOLE
 WITHOUT THE WRITTEN PERMISSION OF
 BLK LBL CORP. IS PROHIBITED.

		UNLESS OTHERWISE SPECIFIED:		NAME	DATE
		DIMENSIONS ARE IN INCHES		DRAWN	JA 11/20/17
				CHECKED	
				ENG APPR.	DB 11/20/17
				MFG APPR.	JA 11/20/17
				Q.A.	
				COMMENTS:	
MATERIAL					
FINISH		ANODIZE TYPE II			
NEXT ASSY	USED ON				
APPLICATION		DO NOT SCALE DRAWING			

BLK LBL

TITLE:
AR15 BLKLBL BIPOD ASSEM. 16IN

SIZE	DWG. NO.	REV
B		A

SCALE: 1:1.1 WEIGHT: 1.81LB SHEET 1 OF 1

4

3

2

1

B

B

A

A